

Example schematic 1

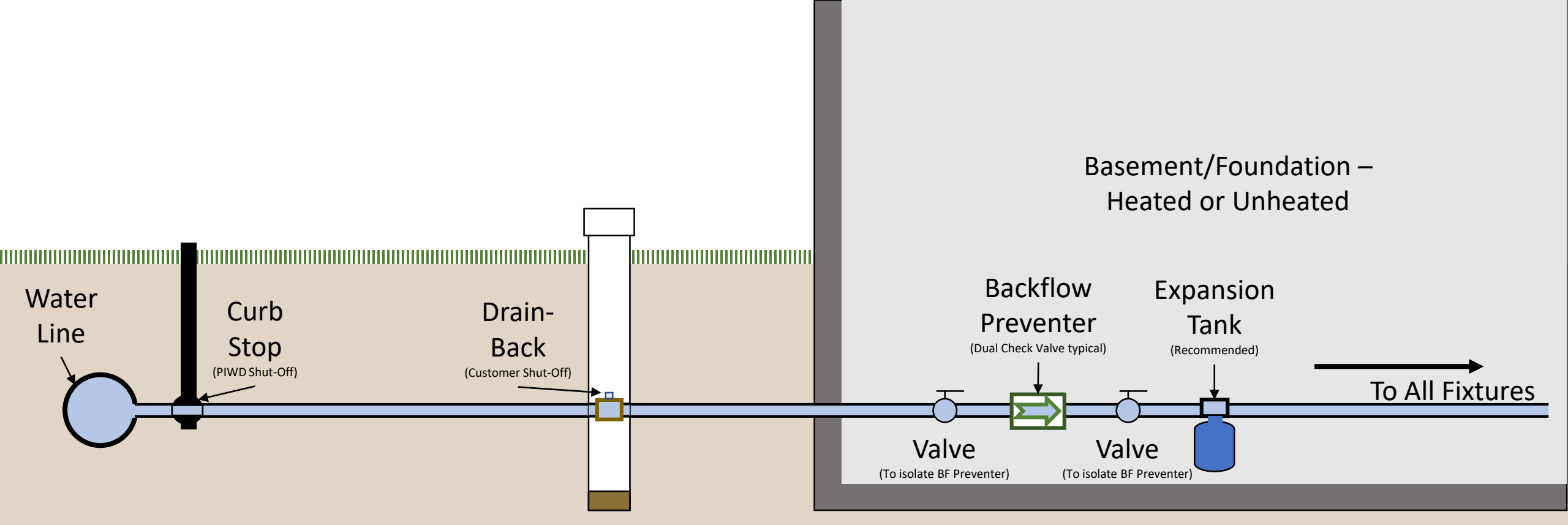

Example schematic 2

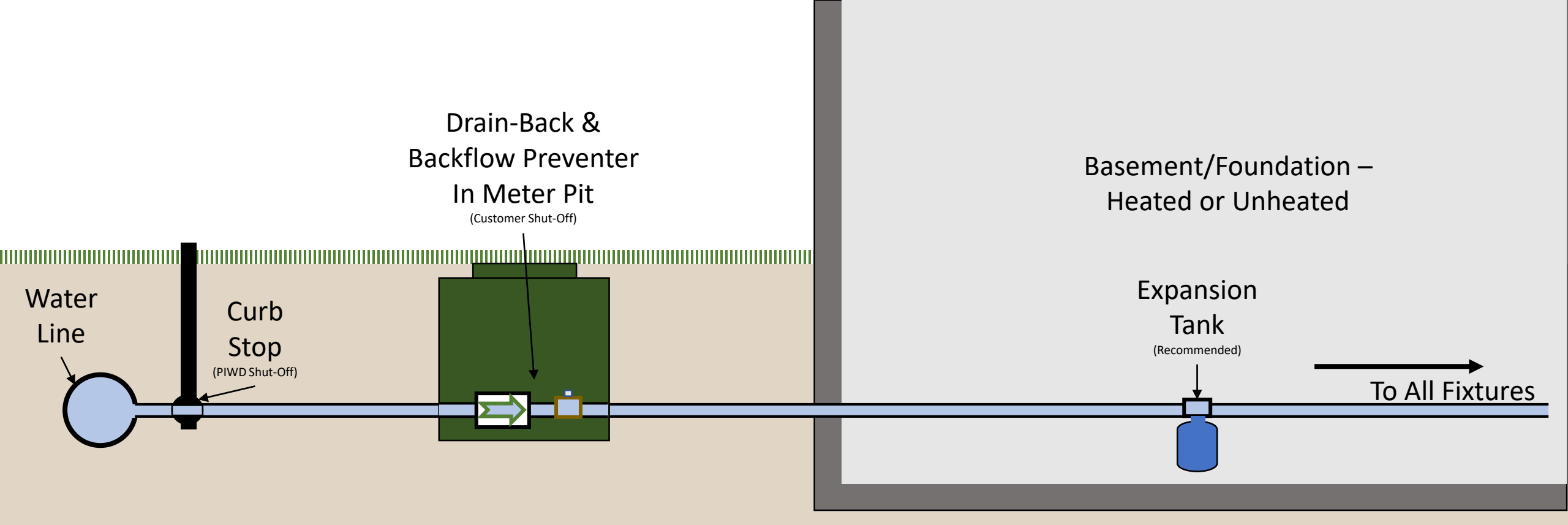

Example schematic 3

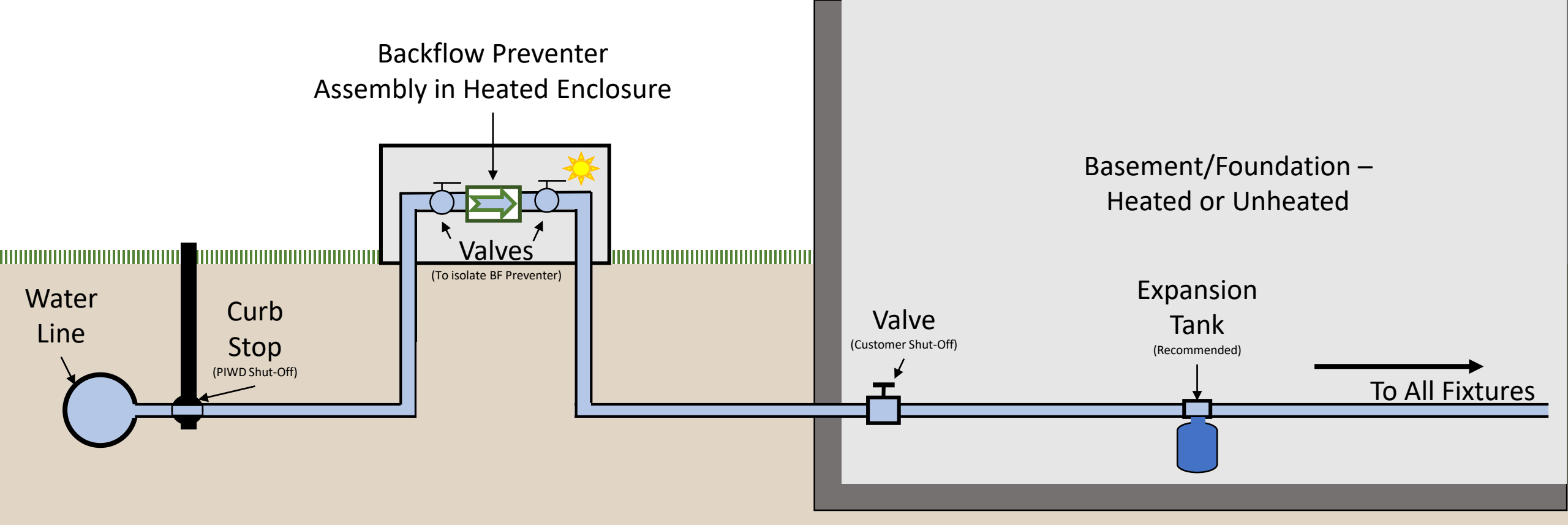

Example schematic 4

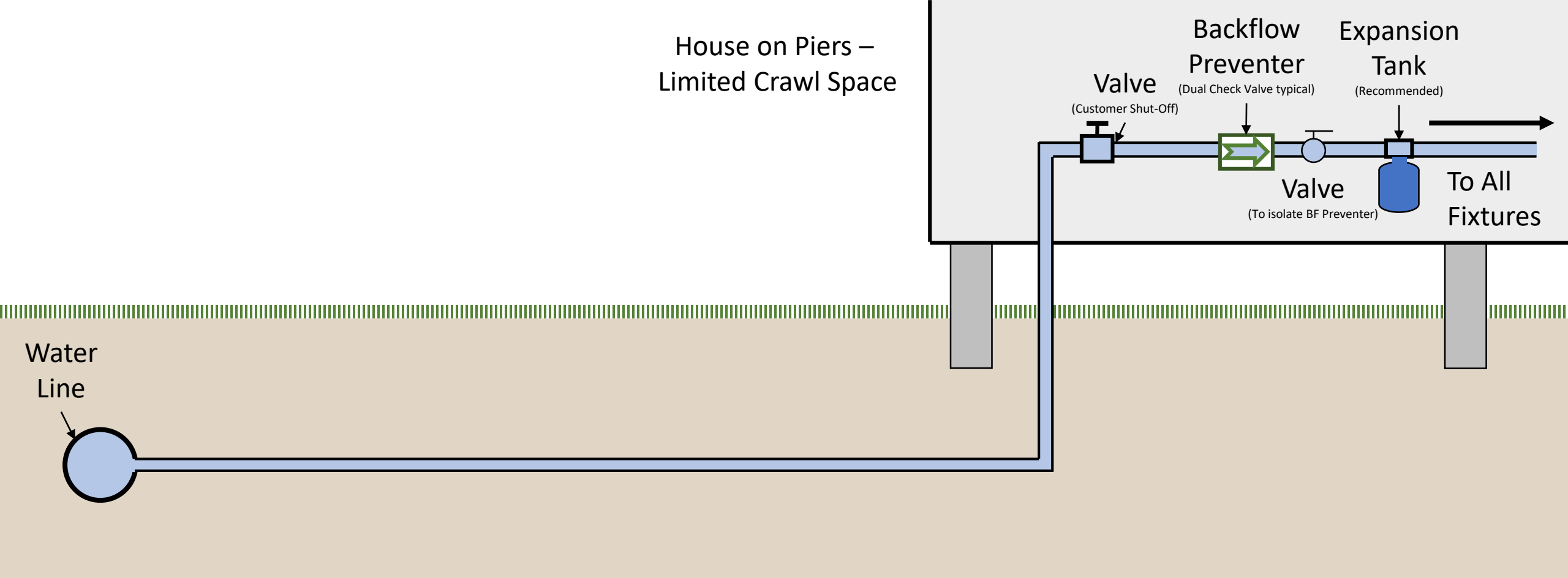

Example schematic 5

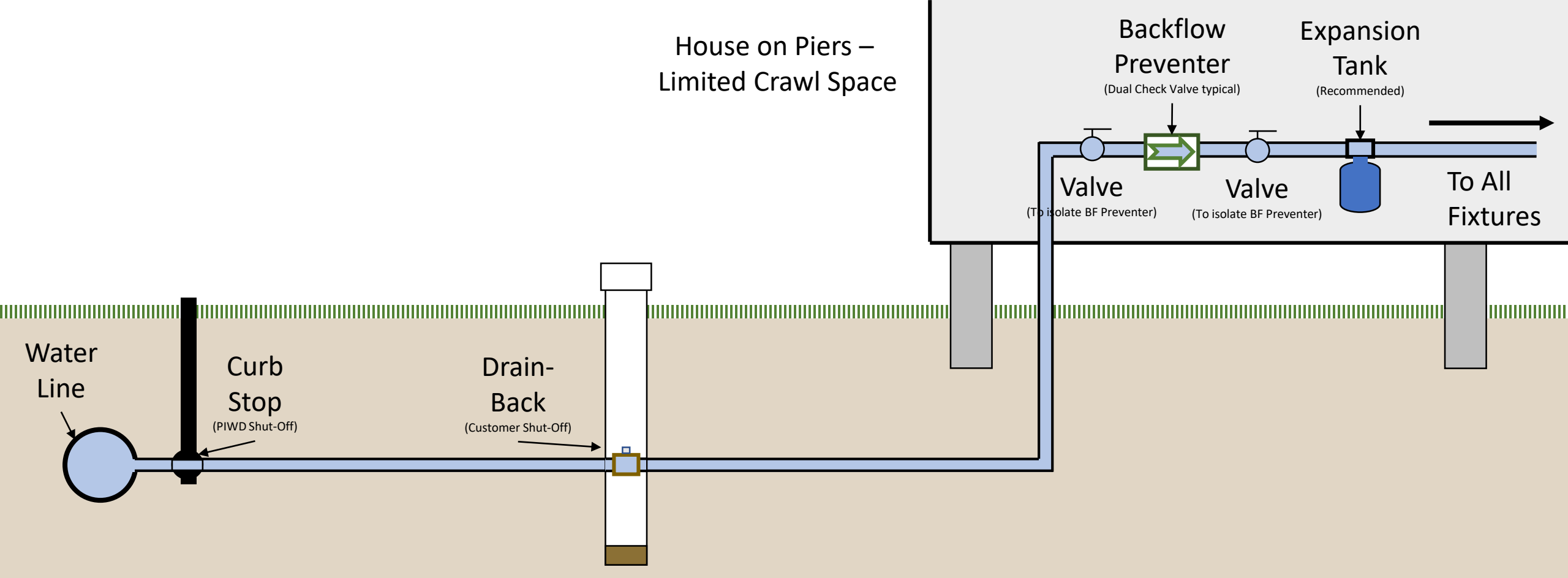

Example schematic 6

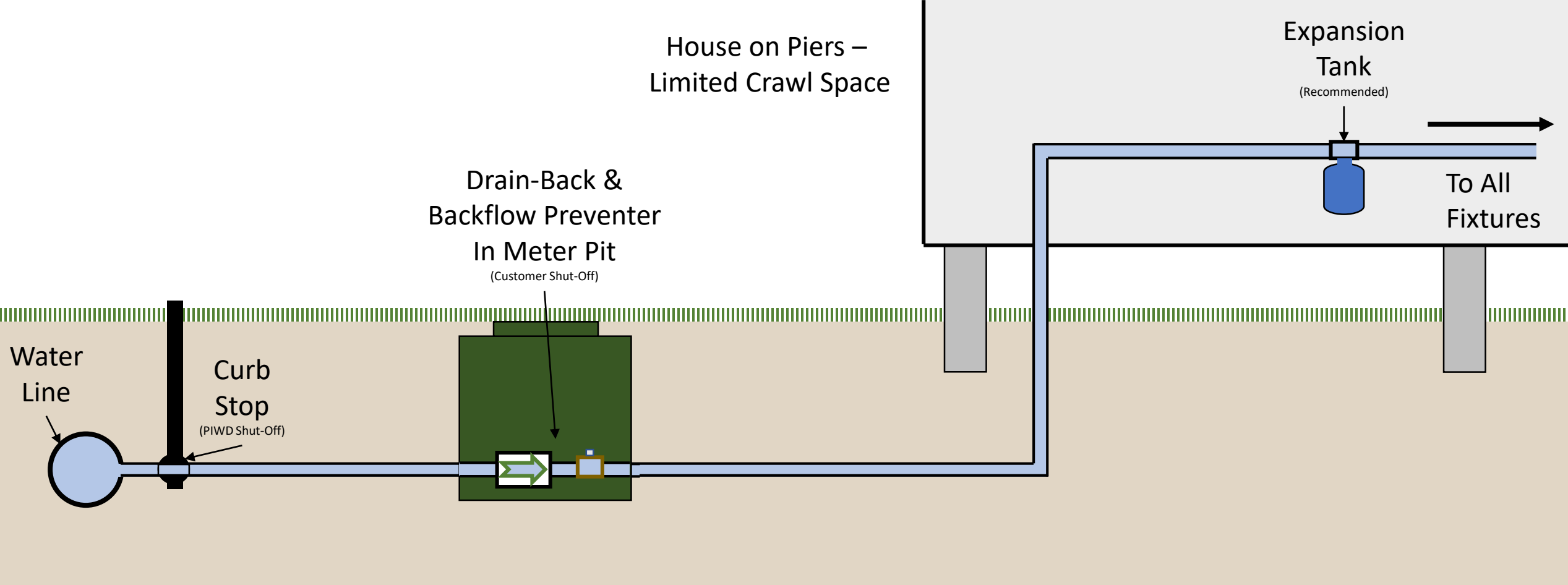

Example schematic 7

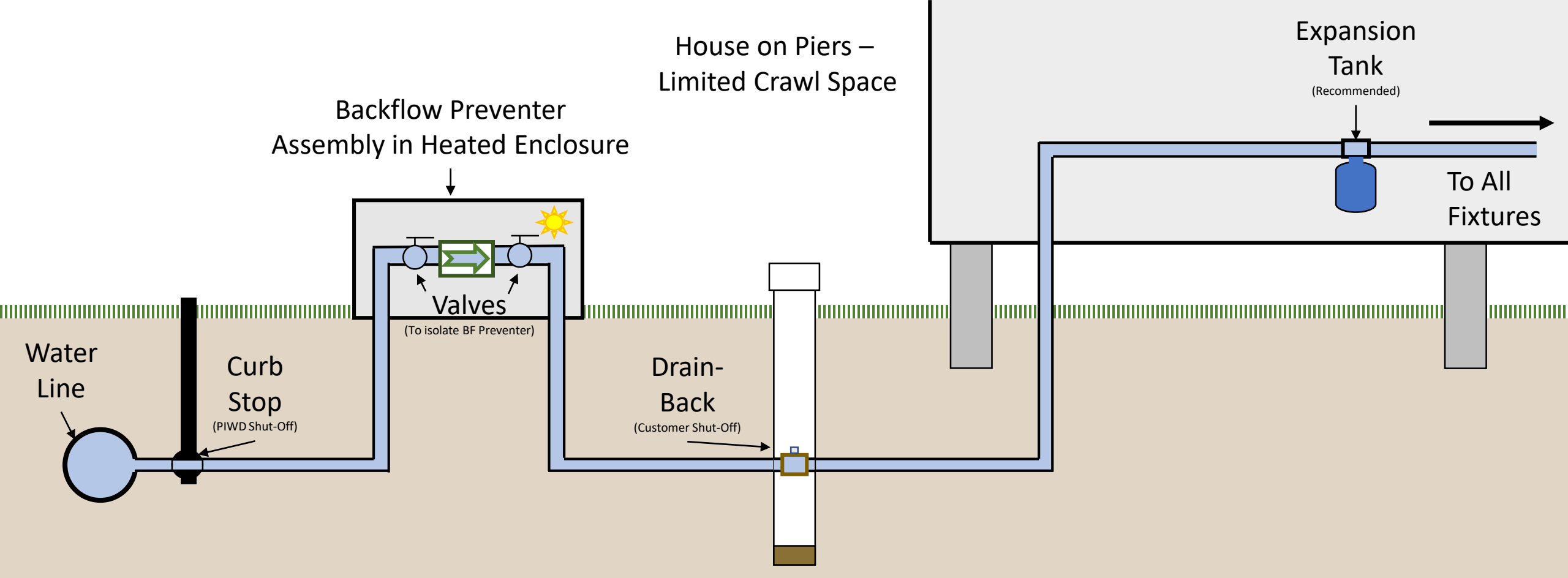

Example schematic 8

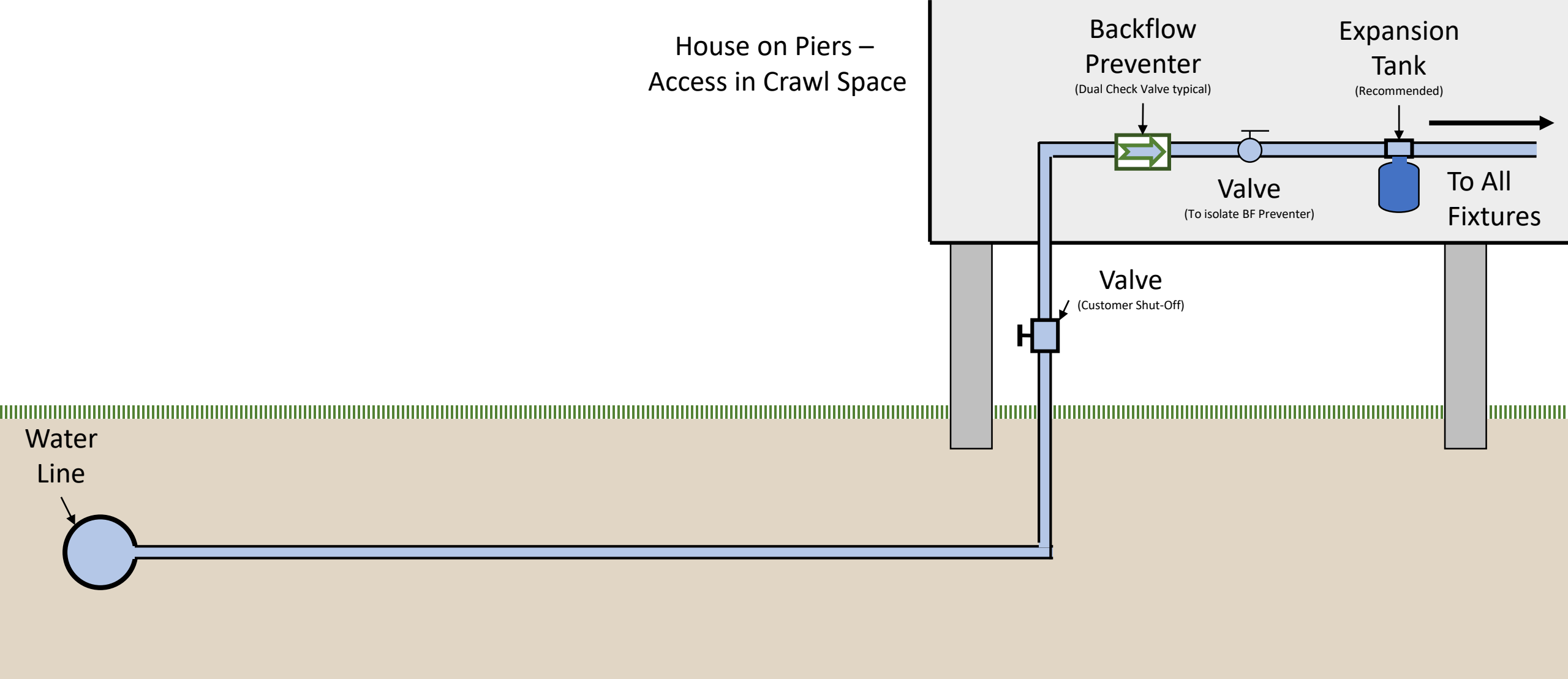

House on Piers –
Access in Crawl Space

Backflow
Preventer

(Dual Check Valve typical)

Expansion
Tank

(Recommended)

Valve

(To isolate BF Preventer)

To All
Fixtures

Valve

(Customer Shut-Off)

Water
Line

Example schematic 9

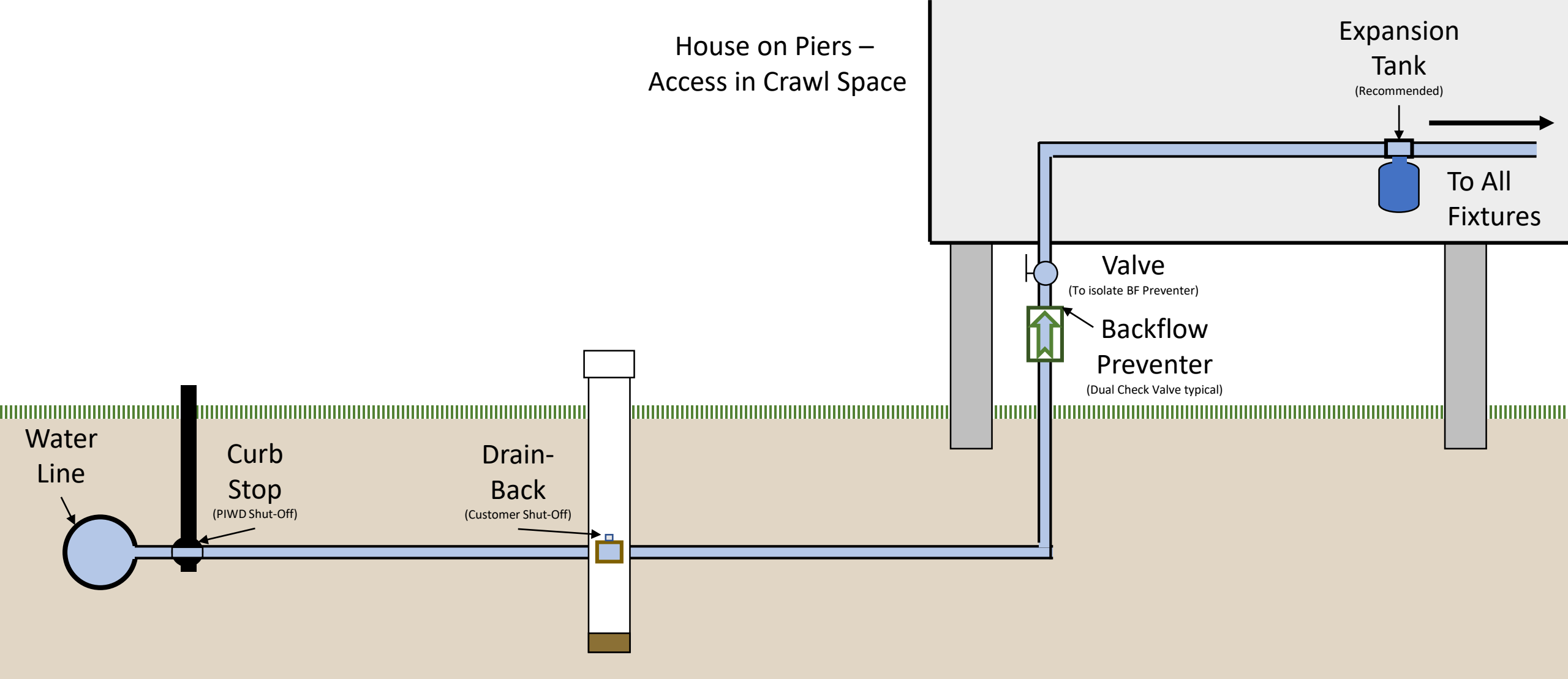

Example schematic 10